

instruction manual

Motor Starter - 1165127-00000



General information

The diagrams shown in this document may differ from the actual product.

We reserve the right to make technical changes.

The manufacturer does not accept any liability for damage to property or financial losses arising from insignificant defects in the product or insignificant flaws in the documentation, e.g. printing or writing errors, and where the manufacturer has not acted deliberately or been grossly negligent.

Where the names of third-party trademarks are mentioned, this is purely for information purposes.

LQ Mechatronik-Systeme GmbH respects the intellectual property of third parties and always endeavours to state the full designation of third-party trademarks and to state the owner of the respective rights.

If no indication is given of protected rights in an individual case, this does not give the right to assume that the trademark is not protected.

© Copyright 2019 LQ Mechatronik-Systeme GmbH

Trademarks marked with ® are registered trademarks of LQ Mechatronik-Systeme GmbH.

LQ Mechatronik-Systeme GmbH

Carl-Benz-Strasse 6

74354 Besigheim

Table of contents

1	Conventions for presentation (Symbols used and warning notices)	4
1.1	Abbreviations (glossary)	4
2	General	4
2.1	Functions of this document	4
2.2	Target group	4
2.3	Specifications	5
2.3.1	Specification AS-i	5
3	Security	5
3.1	Qualified employees	5
3.2	Opening the casing cover	5
3.3	Field of application	5
3.3.1	General	5
3.3.2	AS-i not Safe	5
3.3.3	Switching characteristic On/Off	5
4	Product description	6
4.1	Product information	6
4.2	Product features	6
4.3	Electrical properties	7
4.4	Mechanical properties	8
4.5	Thermal properties	8
4.6	Chemical properties	8
4.7	Approval	8
5	Parameterisation	9
5.1	Parametrization of the function	9
5.1.1	Overview and arrangement of components (schematic circuit diagram)	9
5.1.2	AS-i Device not Safe	10
5.1.2.1	General description of the AS-i function	10
5.1.2.1.1	Outputs Out1 - Out3	10
5.1.2.1.2	Inputs In1 – In4	10
5.1.2.2	Addressing the non-safe AS-i node (-K1)	11
5.1.3	Motor protection switch 3RV2011-XXXXX	12
6	Assembly	13
6.1	Housing dimensions	13
6.2	Dimensional drawing	13
6.3	Assembly of several modules next to each other	14
7	Interface description	15
7.1	-X10 X-TEC15 male - Input 400V AC / 24V DC	15
7.2	-X11 M12 A- Coded - Communication AS-i	15
7.3	-X11 M12 A- Coded - Communication Parallel	15
7.4	-X20 X-TEC15 female - Output 400V AC	15
8	Diagnosis	16
8.1	General description of Service Levels 1 and 2	16
8.1.1	Service Level 1	16

8.1.2	Motor (consumer) does not work.....	16
8.1.3	Service Level 2.....	16
8.1.3.1	Status LEDs AS-i device.....	17
8.1.3.2	Status Motor protection switch	18
9	Markings / labels Case.....	19
9.1	Label "Serial number" on the side of the module.....	19
9.2	"WARNING" label on the side of the module.....	19
9.3	Label "Name, Ratings, Approvals" on the front of the module.....	19
9.4	Ratings "label" (UL-SCCR and Enclosure).....	20
9.5	Label Operating note AS-i module on the inside of the cover.....	21
10	Disposal.....	22

1 Conventions for presentation (Symbols used and warning notices)

This document may contain various warning words and warning symbols that indicate potential hazards:



Important:

This symbol makes the reader aware of important information.



Caution!

This symbol warns of a possible fault. If this is not followed, the unit or systems and equipment connected to it may be disrupted or even fail completely.



Warning!

This symbol warns about a hazard. If this message is not followed, there is a threat that people may be injured or even killed or property may be damaged or destroyed.

1.1 Abbreviations (glossary)

Abbreviation	Description
AS-i	AS-Interface (Actuator Sensor Interface)
SaW	Safety at Work, AS-i safety technology
MG	Module housing

2 General

Please read through all the documentation provided carefully and in full before you use the unit. Always follow the instructions, information and warnings contained in this documentation and note the technical specifications.

Make sure that all the documents are kept in a legible state and in a suitable place so that they can be consulted again at a later date.

2.1 Functions of this document

These operating instructions provide the technical staff from the machine manufacturer/machine operator or plant manufacturer/plant operator with information on safe installation, electrical installation, configuration and parametrization as well as how to operate and maintain the function.

2.2 Target group

The operating instructions are aimed at the planners, developers and operators of the plants that are supposed to be kept safe by one or more modules. These instructions are also intended for people who integrate the functions into a machine, start it up for the first time or maintain it.

2.3 Specifications

2.3.1 Specification AS-i

The function supports the AS-i specification 3.0, although the earlier specifications (2.1 and 2.0) are compatible.

3 Security

The purpose of this chapter is to ensure your safety and the safety of the plant users. Only use this unit if it is in perfect technical condition and in accordance with the purpose intended, paying attention to safety and hazards.

3.1 Qualified employees



The equipment may only be started up and maintained by knowledgeable personnel. Knowledgeable means anyone who:



- has appropriate technical training
- has been instructed by the machine operator on how to operate the machine and on the current safety guidelines
- has access to the operating instructions.

3.2 Opening the casing cover



Only an authorised person with appropriate technical training, who has been instructed by the machine operator on how to operate the machine and on the current safety guidelines, is allowed to open the housing cover during operation or for maintenance and diagnostic purposes.

3.3 Field of application

3.3.1 General

The function is a decentral module for the safe control of actuators, 3-phase motors and asynchronous motors in the AS-i Safety at Work (SaW) safety bus system.

3.3.2 AS-i not Safe

The function is controlled by a master (AS-i Gateway) integrated in the overall system

3.3.3 Switching characteristic On/Off

The function allows a consumer to be switched on and off.

4 Product description

This Chapter provides you with information about the special properties of the function "Protecting, switching – 400VAC/0,6 - 16A as ON/OFF or/and R/L motors".
It describes the function, configuration and parametrization of the module.



Warning!

You must read this chapter before assembling, installing and starting up the unit.

4.1 Product information

These operating instructions apply to the following LQ function:
Protect Switch 400V motors 8A 1165127-00000

4.2 Product features

current monitoring: NO
Reversing switch: NO
EXECUTION: PROTECTOR
Switching characteristics: On / Off
communications system: AS-i

4.3 Electrical properties

DESIGNATION	VALUE	UNIT
Line protection back-up fuse	16	A
Input voltage Rated value	400 / 480	V AC
Input current Rated value	8	A
Rated frequency	50 / 60 (+/- 10%)	Hz
Surge voltage Rated value	2,5	kV
control voltage	24 (-20% ... +10%)	V DC
Auxiliary current	300	mA
load voltage	600 maximum	V AC
load current	5,5 - 8 adjustable	A
usage category	8A at AC-3	
dissipation	10	W
Switching frequency with AC-3	750	1/h
current monitoring	NO	
EXECUTION	PROTECTOR	
Switching characteristics	On / Off	
Tripping class according to IEC 60947	Class 10	
Electromagnetic compatibility	in accordance with EN 61000-4-2/3/4/5/6/8/11/29/39, EN 55011 Radiated, EN 55011 Conducted	
communications system	AS-i	
AS-i voltage	26,5 - 31,6	V DC
AS-i specification	3.0	

4.4 Mechanical properties

DESIGNATION	VALUE	UNIT
Interface Input	1x X-TEC15 + 1x M12 A-coded	
Interface Output	1x X-TEC 15	
Reversing switch	NO	
Installation altitude above normal zero	2000	m
TYPE OF PROTECTION	IP54	
Mechanical life	100.000 switching cycles	
Shock resistance according to EN 60068-2-27	15g/11ms, 6g/11ms (electrical)	
Vibration according to EN 60068-2-6	10-500Hz, 0,35mm, 5g	
Vibration according to EN 60068-2-64	5-500Hz, 0,75g RMS	
Impact resistance Housing	IK08 as per DIN EN 5012/VDE 0470 Part 100	

4.5 Thermal properties

DESIGNATION	VALUE	UNIT
Ambient temperature (operation)	-20 to +45	°C
Ambient temperature (storage)	-25 to +80	°C

4.6 Chemical properties

DESIGNATION	VALUE	UNIT
Housing material	Polycarbonate, glass fibre reinforced	
Burning behaviour Housing	5VA in accordance with UL 50 / UL 746C, V-2 in accordance with UL 94, 960°C in accordance with VDE 0471 / EN 60695	
Max. relative humidity	95% in case of 25°C and 50% in case of 40°C	
stability	UV/weather/weak acid/alcohol/mineral oil/ammonia gaseous/greases	

4.7 Approval

DESIGNATION	VALUE	UNIT
policies	RoHS Directives, REACH Regulation	

5 Parameterisation

5.1 Parametrization of the function



Before starting up, various settings must be made on different components within the module. The cover must be removed from the module to do this. When doing this, all information in the document and on the module housing must be noted and complied with.



During parameterization the module must be in operating condition with operating voltage (24VDC) applied at -X10.

5.1.1 Overview and arrangement of components (schematic circuit diagram)

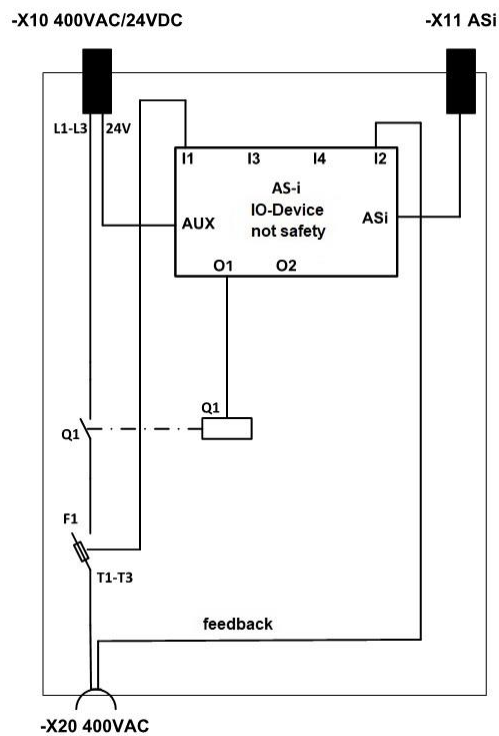
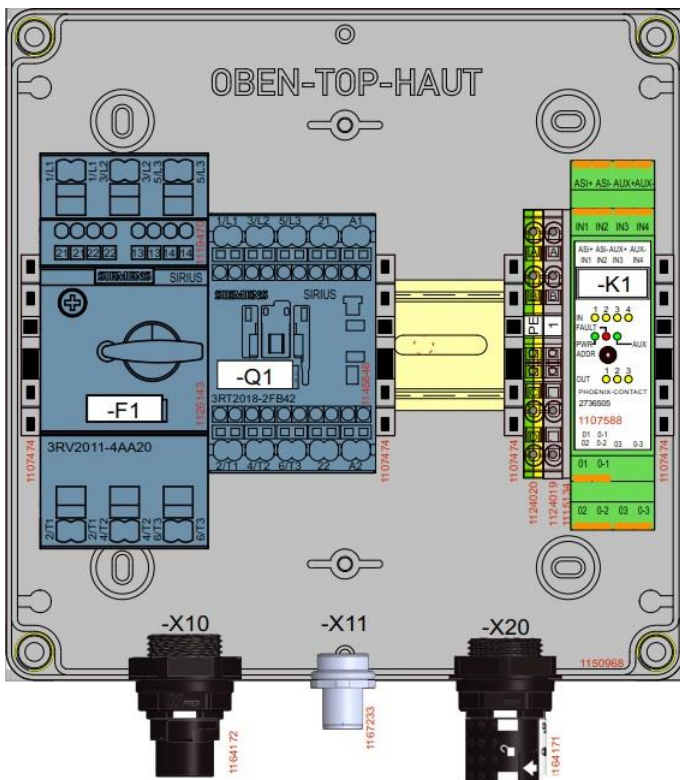

- K1 -> AS-i
- F1 -> Motor protection switch
- Q1 -> Contactor

5.1.2 AS-i Device not Safe

General description of the data of a non-safe AS-i participant

The function has an AS-i address

AS-i address	Description of the function
X	address (4 x In / 3 x Out)

The AS-i participant (address) has 4-bit data each (bidirectional)

Bit	Meaning / Data bit Master -> Node	Meaning / Data bit Node -> Master
0	Output 1	Input 1
1	Output 2	Input 2
2	Output 3	Input 3
3		Input 4

Below, the data bits are each shown as a function of the address as follows::

Address.Bit

Example for address X bit 1, which represents one input or output:

X.0 (Out1/In1)

5.1.2.1 General description of the AS-i functionn

The module has an AS-i station that fulfills the following functions.

The function is described by an own AS-i address.

The addressing of the AS-i device is described in chapter 5.1.2.3.

5.1.2.1.1 Outputs Out1 - Out3

The participant has 3 outputs which are used in the function for switching on and off including reversing operation by a three-phase motor.

Function output	Bit (output)
Clockwise	X.0 (Out1) = 1 X.1 (Out2) = 0
Anti-clockwise	X.0 (Out1) = 0 X.1 (Out2) = 1
Motor off	X.0 (Out1) = 0 X.1 (Out2) = 0

5.1.2.1.2 Inputs In1 – In4

The participant has 4 inputs on the address, which are used in the function as follows

Function	Bit (input)
Motor overload tripped	X.0 = 1
Temperature switch, motor	X.1 = 1
Automatic (auto) mode*1	X.2 = 1 X.3 = 0
Manual (man) mode*1	X.2 = 0 X.3 = 1
Motor off*1	X.2 = 0 X.3 = 0
Current monitoring ²	X.2 = 1 X.3 = 0

*1 optional with knob-operated control

*2 optional with current monitoring

*1 and *2 in combination not possible

5.1.2.2 Addressing the non-safe AS-i node (-K1))

The non-safe AS-i device uses only 7 data bits. The 8th bit is used for the address extension of the AS-i participant address. This means that instead of 32 participants, 64 participants can be connected to the bus and addressed.

The double addressing possibility is achieved by dividing the AS-i participant addresses into an A and B address.

In this way, 32 A-addresses and 32 B-addresses can be assigned for a total of 64 participants.

The prerequisite is that the participant is designed for this addressing option and that the 8th data bit is provided as the participant address.

A participant who does not have the option of using a half address always occupies a full address, i.e. the B address is no longer available to the system for this address.



Note!

Addressing is done directly on the component and is described here in the document exclusively with a manual addressing device.

5.1.3 Motor protection switch 3RV2011-XXXXX

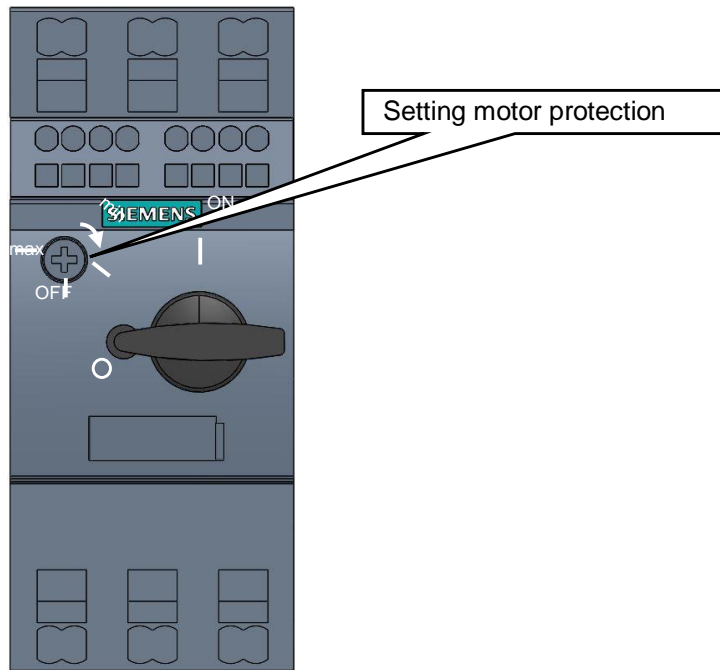

	Motor protection variants						
	0,8A	2A	4A	6,3A	8A	12A	16A
Setting range in A	0,55 - 0,8	1,4 - 2	2,8 - 4	4,6 - 6,3	5,5 - 8	9 - 12	10 - 16

6 Assembly

6.1 Housing dimensions

DESIGNATION	VALUE	UNIT
Size of construction (Width x Height x Depth)	200 x 219 x 166	mm
Distance to be maintained below	170	mm
Distance to be maintained laterally	30	mm
installation type	screw fastening	
installation position	vertical installation	

6.2 Dimensional drawing

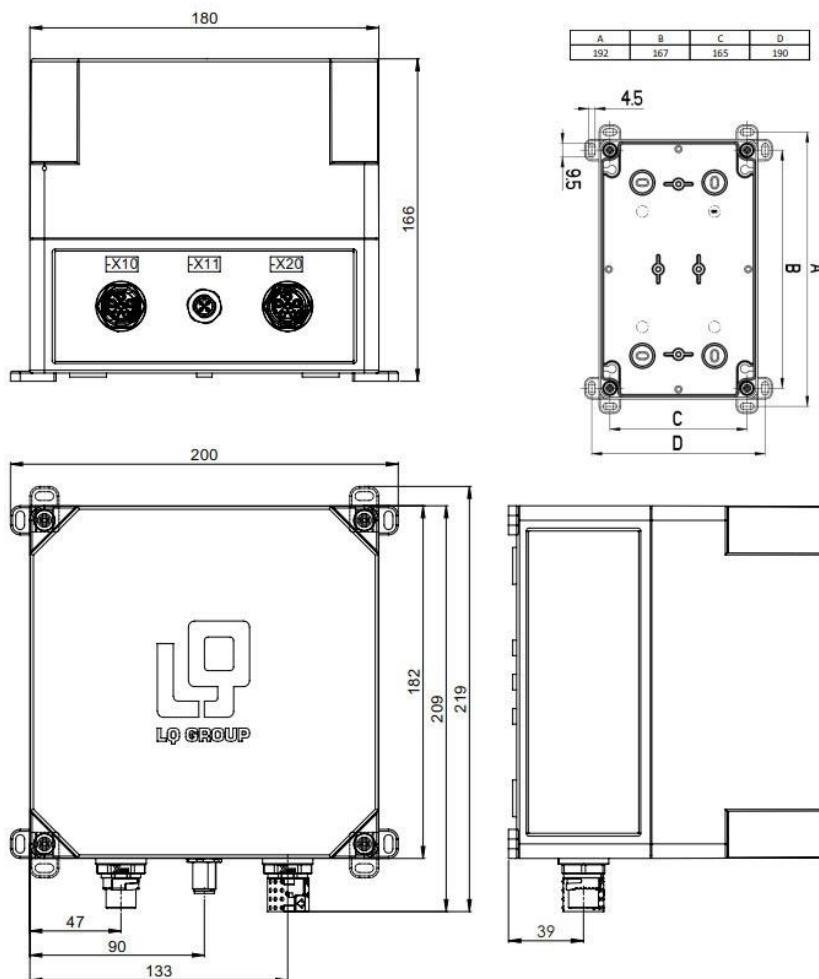

6.3 Assembly of several modules next to each other



When assembling several module housings (MG) next to each other, minimum clearance of 30mm is required; when assembling several module housings next to each other vertically, a minimum clearance from the upper edge of the housing (MG3) to the lower edge of the housing (MG1) of 170 mm must be complied with so that, first, the thermal characteristics are not affected and, second, so that the connecting lines can be routed correctly.

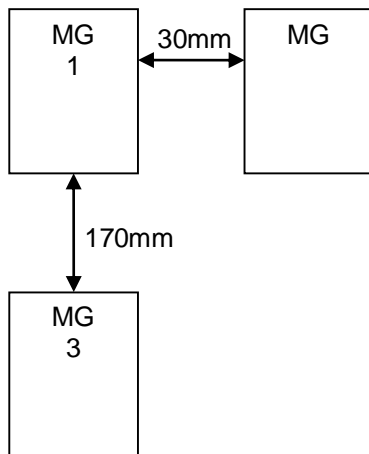

7 Interface description

7.1 -X10 X-TEC15 male - Input 400V AC / 24V DC

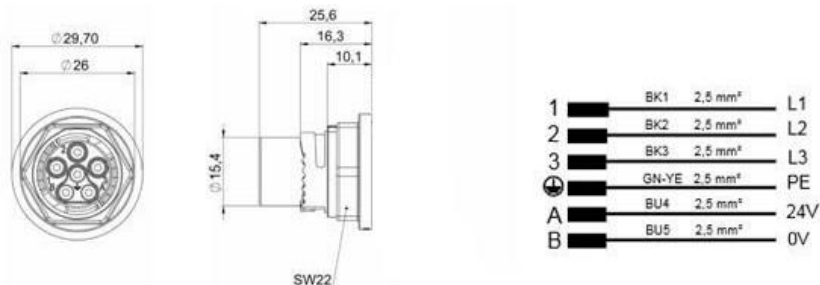

7.2 -X11 M12 A- Coded - Communication AS-i

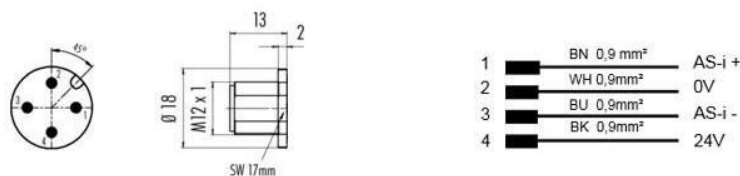

7.3 -X11 M12 A- Coded - Communication Parallel

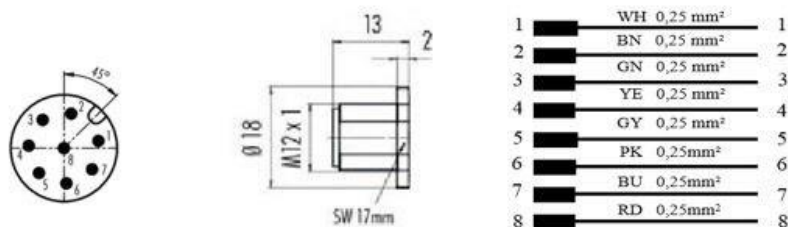

7.4 -X20 X-TEC15 female - Output 400V AC

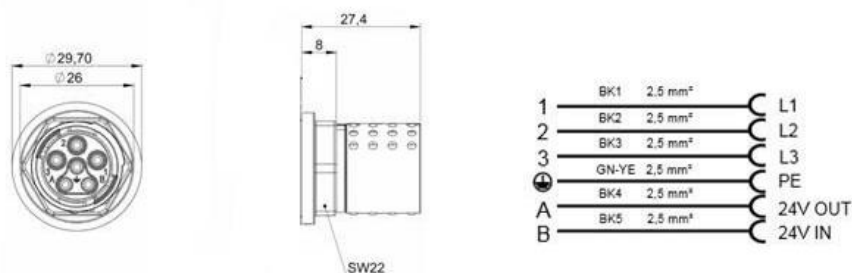

Pin A/B in interface -X20 is used for thermal monitoring of the motor temperature via a bimetal.

8 Diagnosis

8.1 General description of Service Levels 1 and 2

8.1.1 Service Level 1

In Level 1, all possible causes of faults are described for which it is not necessary to open the module cover (no specialist electrical knowledge required).

8.1.2 Motor (consumer) does not work

- ✓ Are all the necessary connecting cables

- --X10 400V input
- -X20 400V output and
- -X11 Communication bus (AS-i or parallel)

connected at the module and latched in position correctly?

- ✓ Is the –X10 400V input cable properly connected to the intended power source and are all fuses switched on there?
- ✓ Is the –X20 400V output cable properly connected to the intended consumer?
- ✓ Is the AS-i Bus connecting cable –X11 properly connected at the bus?
- ✓ Is one of the properly connected connecting cables –X10, -X11 and –X20 damaged?

8.1.3 Service Level 2

In Service Level 2, the cover must be opened in order to evaluate the diagnostic displays of the individual components.

Depending on the type of function, the components may be different and are described below.

No specialist electrical knowledge is required.

The safety guidelines in chapter 3 *Safety* must be observed.















When the module lid is open, diagnostic messages of the individual components can be read and evaluated as follows

Component overview

- Safe AS-i participant
- Non-safe AS-i participant
- Electronic load relay ELR
- current monitoring
- motor-protective circuit-breaker
- line contactor

8.1.3.1 Status LEDs AS-i device

AS-i not safety

LEDs	Status	Signal Description
PWR	green	AS-i <u>operating voltage</u>
		 <u>No operating voltage</u>
		 <u>Operating voltage available</u>
FAULT	red	Error <u>display</u>
		 <u>No error</u>
		 <u>Communication error or AS-i address = 0.</u>
		 <u>Overload of the outputs</u>
AUX	green/ red	External <u>auxiliary voltage</u>
		 <u>Auxiliary voltage not available.</u>
		 <u>Auxiliary voltage available.</u>
		 <u>Auxiliary voltage reverse polarity.</u>
I1, I2, I3, I4	yellow	Status of the <u>inputs</u>
		 <u>Input not active.</u>
		 <u>Input active.</u>
O1, O2, O3	yellow	Status of the <u>outputs</u>
		 <u>Output not active.</u>
		 <u>Output active.</u>
		 LED off  LED flashing  LED on

8.1.3.2 Statsu Motor protection switch

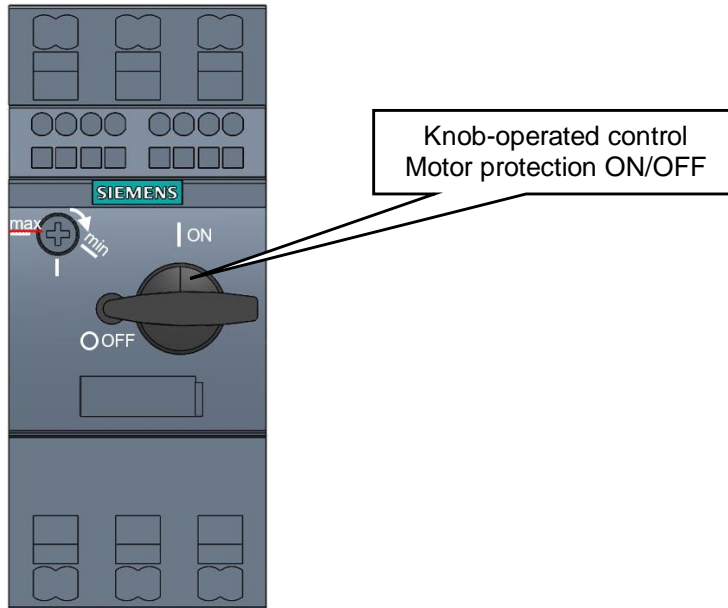

If the consumer is overloaded, the motor protection trips (switch position = 0 Off). This can have various reasons, which should be checked in advance before the motor protection switch is put back into operation via the toggle switch by moving the switch to the I ON position.



Before the motor protection switch is put back into operation, the function should possibly be switched off in advance via the higher-level control.



It should be noted that the connected consumer starts up again immediately if it has not been explicitly switched off beforehand via the controller.

9 Markings / labels Case

9.1 Label "Serial number" on the side of the module

The diagram describes the shape and structure of the label. The illustration serves only as an example.

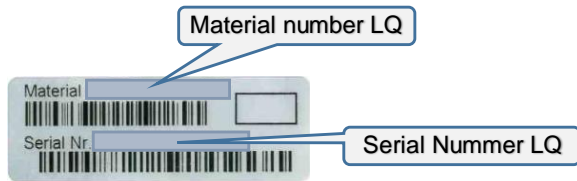

9.2 "WARNING" label on the side of the module

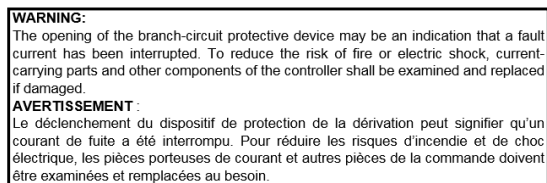

9.3 Label "Name, Ratings, Approvals" on the front of the module

The diagram describes the shape and structure of the label. The illustration serves only as an example. The data can be determined either from the properties or directly from the label on the module



9.4 Ratings "label" (UL-SCCR and Enclosure)

SCCR

"SUITABLE FOR USE ON A CIRCUIT CAPABLE OF DELIVERING NOT MORE THAN 50,000 RMS SYMMETRICAL AMPERES; 480 V MAXIMUM WHEN PROTECTED BY J CLASS FUSES RATED 60A OR CC CLASS FUSES RATED 30A OR WHEN PROTECTED BY A CIRCUIT BREAKER HAVING AN INTERRUPTING RATING NOT LESS THAN 50,000 RMS SYMMETRICAL AMPERES; 480 VOLTS MAXIMUM", or equivalent. Circuit breaker types can be marked in the instruction manual.

SCCR Group Installation:

"In combination with Manual Motor Controller Siemens 3RV2.1 or 3RV2.2 suitable for group installation on a circuit capable of delivering not more than 50 kA rms Symmetrical Amperes, 480 Volts Maximum, when protected by 25 A Class J or CC fuses or when protected by a Listed Siemens Circuit Breaker with a marked short-circuit rating equal or larger than the available short-circuit current rating", or equivalent.

Enclosure Type Rating: 1

9.5 Label Operating note AS-i module on the inside of the cover

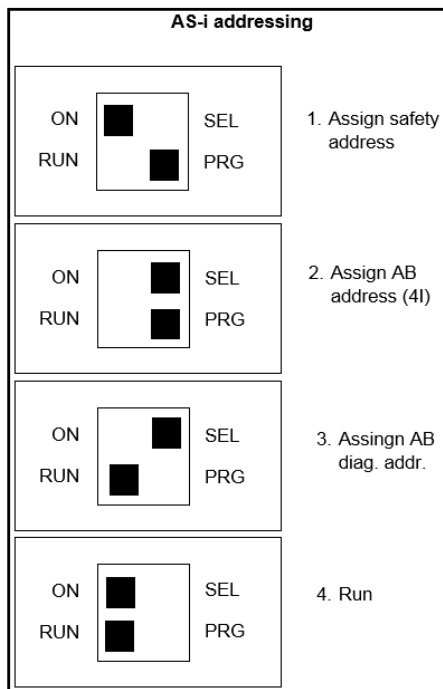

10 Disposal



Important:

Handle and dispose of the equipment and components used correctly.
Dispose of equipment that can no longer be used as special waste.
Comply with national and local directives for disposal.