

1 Datasheet W-TEC 15K STI/BU 6x2,5 DA0

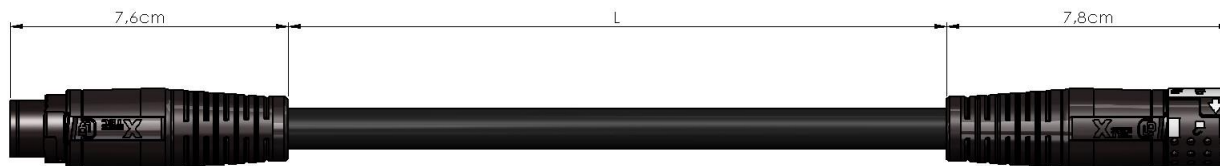

source

destination

xxxxx (see order no:) stands for the length in cm.

2 Application

Cable for the connection of asynchronous motors and 3-phase consumer's with 2 Signalpins

3 General component properties

3.1 Cataloguing

DESIGNATION	VALUE	UNIT
product designation of manufacturer	W-TEC 15	
MANUFACTURER ARTICLE NUMBER	1138014	
Product utilization of the cable	PERFORMANCE	
UL Mark	UL Listed	
eCl@ss 9.0	27-06-04-90	
country of origin	DE	

27.10.2023-RSP	Adaptation Eclass	12.0		UL- Identification	Order no.	
17.04.2019-CP	Creation	11		W-TEC 15K-GCS-GCS-61414-XX-PX	1138014-xxxxx	
12.11.2018-JH	Creation	10		Designation	Datasheet	
03.08.2023-RSP	New: IEC 61076-2-116	6.0		W-TEC 15K STI/BU 6x2,5 DA0	Created	Page
Change No.	Description of changes	Index			27.10.2023-RSP	1

The information contained in this data sheet was compiled with the greatest possible care.
For correctness, completeness and topicality the liability is limited to gross negligence.
All rights reserved to DIN 34

LQ Mechatronik-Systeme GmbH
Carl-Benz-Str. 6 D-74354 Besigheim
Tel. +49 (0) 71 43 / 968-0 - info@de.lq-group.com

3.2 Electrical properties

DESIGNATION	VALUE	UNIT
Rated value of current	16	A
Rated current auxiliary wires	10	A
rated voltage	600	V AC
Rated voltage auxiliary wires	250	V AC / DC
rated impulse voltage	6	kV
shield	No	
Design of ground wire	according to VDE 0627	
Overvoltage category according to DIN EN 60664-1	3	
Plugging under voltage according to DIN EN 61984	No	
degree of contamination	3	
earthed conductor present	yes (PE) leading on pin side 1,2mm	
neutral conductor	No	
Degree of protection by encapsulation according to IEC 60529	No	
Application standards	DIN EN 61984 / IEC 61076-2-116	

If the plug connection is disconnected for an indefinite period of time from a exposed to industrial atmospheres, the contact chamber is equipped with a cover cap to protect against pollution.

*To determine max. load currents, deratings for used connection conductor cross-sections as well as reduction factors for conductors, cables and lines in the electrical equipment of machines according to DIN EN 60204-1 must be taken into account.

3.3 Weights

DESIGNATION	VALUE	UNIT
Connection 1	224	g/m
Connector Source	20	g
Connector Target	24	g

3.4 Approval

DESIGNATION	VALUE	UNIT
UL.CCN **	PVVA.E486020	
CSA.CCN **	PVVA7.E486020	
CCC	No	
GOST-R	No	
CE Nomenclature	W-TEC 15K-GCS-GCS-61414-XX-PX	

3.4.1 Approvals Supplements

** Suitable For Use On a Circuit Capable Of Delivering Not More Than 5,000 rms Symmetrical Amperes, 600V Maximum.

When Protected by Time Delay (See Table Below) Class Fuses:

27.10.2023-RSP	Adaptation Eclass	12.0		UL- Identification	Order no.	
17.04.2019-CP	Creation	11		W-TEC 15K-GCS-GCS-61414-XX-PX	1138014-xxxxx	
12.11.2018-JH	Creation	10		Designation	Datasheet	
03.08.2023-RSP	New: IEC 61076-2-116	6.0		W-TEC 15K STI/BU 6x2,5 DA0	Created	Page
Change No.	Description of changes	Index			27.10.2023-RSP	2

The information contained in this data sheet was compiled with the greatest possible care. For correctness, completeness and topicality the liability is limited to gross negligence. All rights reserved to DIN 34

LQ Mechatronik-Systeme GmbH
 Carl-Benz-Str. 6 D-74354 Besigheim
 Tel. +49 (0) 71 43 / 968-0 - info@de.lq-group.com

Cat. No(s).	Time Delay (TD) /Non-time delay (NTD)	Fuse Class	Fuse Current Rating (A)	SCCR (kA)	Voltage V AC
All rated 13 A	TD	RK5	25	5	600
	TD	J	60	50	600
	TD	CC	30	50	600
All rated 16 A	TD	RK5	35	5	600
	TD	J	60	50	600
	TD	CC	30	50	600

Suitable For Use On A Circuit Capable Of Delivering Not More Than 50kA rms Symmetrical Amperes, 480 Vac Maximum, When Protcted By A Circuit Breaker Rated Not More Than 16A, Having An Interrupting Rating Not Less Than 50kA rms Symmetrical Amperes, 480Vac Maximum.

Circuit Breakers:

Cat. No(s).	Model/Type	Manufacturer / UL File	Current Rating (A)	SCCR (kA)	Voltage V AC
All	Any	Any / Any	16	50	480Y/277 Vac

X - T E C 1 5 - - - X X X ...

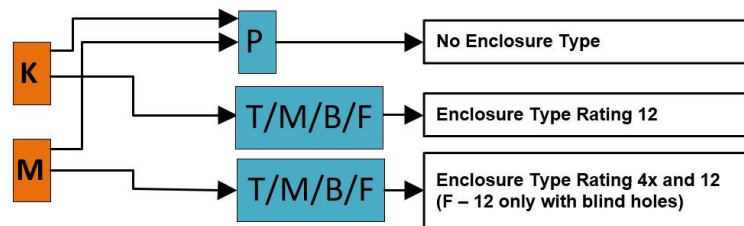

X - T E C 1 5 - X X X - - - ...

3.5 Thermal properties

DESIGNATION	VALUE	UNIT
min. permissible cable outside temperature, when moving	-20	°C
max. permissible cable outside temperature, when moving	60	°C
min. permissible cable outside temperature, fixed laid	-20	°C
max. permissible cable outside temperature, fixed laid	70	°C

27.10.2023-RSP	Adaptation Eclass	12.0		UL- Identification	Order no.
17.04.2019-CP	Creation	11		W-TEC 15K-GCS-GCS-61414-XX-PX	1138014-xxxxx
12.11.2018-JH	Creation	10		Designation	Datasheet
03.08.2023-RSP	New: IEC 61076-2-116	6.0	W-TEC 15K STI/BU 6x2,5 DA0	Created	Page
Change No.	Description of changes	Index		27.10.2023-RSP	3

The information contained in this data sheet was compiled with the greatest possible care. For correctness, completeness and topicality the liability is limited to gross negligence. All rights reserved to DIN 34

LQ Mechatronik-Systeme GmbH
Carl-Benz-Str. 6 D-74354 Besigheim
Tel. +49 (0) 71 43 / 968-0 - info@de.lq-group.com

3.6 UL Ratings

DESIGNATION	VALUE	UNIT
Reference to UL standard	2237	
cross section of the wire (AWG)	14	AWG
Auxiliary wires Wire gauge	14	AWG
Encl. Type (UL 50/CSA C22.2 NO.94.1-15)	12	
Flame resist. of the plug head (UL 94)	HB	
AWM Style of cable	2570	

3.7 Other features

DESIGNATION	VALUE	UNIT
RoHS compliant	2011/65/EU under exception III 6c	
REACH SVHC substances	Lead (CAS 7439-92-1, EC 231-100-4)	
halogen-free	No	
Oil-resistant in accordance EN 60811-2-1	Yes	
flame-resistant	Yes	

The material of the housing-encapsulation is plastic and has a good resistance to chemicals and oil. If aggressive media are used, the material resistance must be checked in relation to the application. Further details on request.

27.10.2023-RSP	Adaptation Eclass	12.0		UL- Identification	Order no.	
17.04.2019-CP	Creation	11		W-TEC 15K-GCS-GCS-61414-XX-PX	1138014-xxxxx	
12.11.2018-JH	Creation	10		Designation	Datasheet	
03.08.2023-RSP	New: IEC 61076-2-116	6.0		W-TEC 15K STI/BU 6x2,5 DA0	Created	Page
Change No.	Description of changes	Index			27.10.2023-RSP	4

The information contained in this data sheet was compiled with the greatest possible care. For correctness, completeness and topicality the liability is limited to gross negligence. All rights reserved to DIN 34

LQ Mechatronik-Systeme GmbH
 Carl-Benz-Str. 6 D-74354 Besigheim
 Tel. +49 (0) 71 43 / 968-0 - info@de.lq-group.com

4 General structure

4.1 Allocation plan

1	■	BK1	2,5 mm ²	(1
2	■	BK2	2,5 mm ²	(2
3	■	BK3	2,5 mm ²	(3
⊕	■	GN-YE	2,5 mm ²	(⊕
A	■	BK4	2,5 mm ²	(A
B	■	BK5	2,5 mm ²	(B

4.2 Cable

4.2.1 Cable construction

DESIGNATION	VALUE	UNIT
Structure Line	6 x 2,5mm ²	
Number of wires	4	
conductor cross-section	2,5	mm ²
max. main core diameter incl. insulation D	2,4	mm
Auxiliary wires Number	2	
Auxiliary wires Wire gauge	2,5	mm ²
max. auxiliary core diameter incl. insulation D	2,4	mm
outer shield	No	
internal shield	No	
color of the outer sheath	black similar to RAL 9005	
material of the sheath	PVC	
coat colour main wires	black/green-yellow	
coat colour auxiliary wires	black	
Identification of main wires	consecutive number imprint (1-3)	
Identification of auxiliary wires	consecutive number imprint (4-5)	
Core insulation material	PP	
outside diameter	11,1 ±0,3	mm
insulation resistance	>= 20	MΩm/km

4.2.2 Mechanical properties

DESIGNATION	VALUE	UNIT
installation type	solid	
dynamic value	DA0	
Minimum bending radius fixed	5	xD mm

27.10.2023-RSP	Adaptation Eclass	12.0		UL- Identification	Order no.	
17.04.2019-CP	Creation	11		W-TEC 15K-GCS-GCS-61414-XX-PX	1138014-xxxxx	
12.11.2018-JH	Creation	10		Designation	Datasheet	
03.08.2023-RSP	New: IEC 61076-2-116	6.0		W-TEC 15K STI/BU 6x2,5 DA0	Created	Page
Change No.	Description of changes	Index			27.10.2023-RSP	5

The information contained in this data sheet was compiled with the greatest possible care.
For correctness, completeness and topicality the liability is limited to gross negligence.
All rights reserved to DIN 34

LQ Mechatronik-Systeme GmbH
Carl-Benz-Str. 6 D-74354 Besigheim
Tel. +49 (0) 71 43 / 968-0 - info@de.lq-group.com

5 Construction Source

5.1 Pole diagram Source

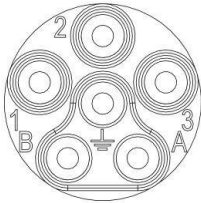

5.2 Construction Source

DESIGNATION	VALUE	UNIT
Size of construction	X-TEC 15	
locking type	Quick release fastener	
Type of plug-in contact, head 1	free plug-in pin	
Number of poles	6	
Arrangement of the cable lead-in, head 1	straight	
Material Seals	NBR	
production type	overmoulded	
Housing material	Technomelt	
Material Insulating body	PA 6.6	
Design of the electrical connection (head 1)	Crimp connection	
Material Contacts	Copper alloy, hard silver plated	
contact resistance	<3	mOhm
Mechanical life Contacts	500	mating cycles
degree of protection	IP66/67	

27.10.2023-RSP	Adaptation Eclass	12.0		UL- Identification	Order no.	
17.04.2019-CP	Creation	11		W-TEC 15K-GCS-GCS-61414-XX-PX	1138014-xxxx	
12.11.2018-JH	Creation	10		Designation	Datasheet	
03.08.2023-RSP	New: IEC 61076-2-116	6.0		W-TEC 15K STI/BU 6x2,5 DA0	Created	Page
Change No.	Description of changes	Index			27.10.2023-RSP	6

The information contained in this data sheet was compiled with the greatest possible care.
For correctness, completeness and topicality the liability is limited to gross negligence.
All rights reserved to DIN 34

LQ Mechatronik-Systeme GmbH
Carl-Benz-Str. 6 D-74354 Besigheim
Tel. +49 (0) 71 43 / 968-0 - info@de.lq-group.com

5.3 Space requirement source

DESIGNATION	VALUE	UNIT
(a1) max. plug diameter	22	mm
(b1) Plug length	76	mm
(x1) in mated condition	116,1	mm
(x2) additional distance to interfering contour plugged in	18	mm

5.4 Schematic diagram Source

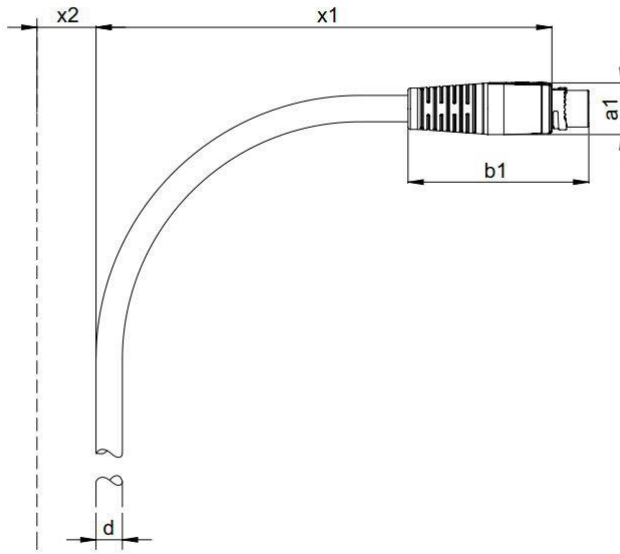

27.10.2023-RSP	Adaptation Eclass	12.0		UL- Identification	Order no.	
17.04.2019-CP	Creation	11		W-TEC 15K-GCS-GCS-61414-XX-PX	1138014-xxxxx	
12.11.2018-JH	Creation	10		Designation	Datasheet	
03.08.2023-RSP	New: IEC 61076-2-116	6.0		W-TEC 15K STI/BU 6x2,5 DA0	Created	Page
Change No.	Description of changes	Index			27.10.2023-RSP	7

The information contained in this data sheet was compiled with the greatest possible care.
 For correctness, completeness and topicality the liability is limited to gross negligence.
 All rights reserved to DIN 34

LQ Mechatronik-Systeme GmbH
 Carl-Benz-Str. 6 D-74354 Besigheim
 Tel. +49 (0) 71 43 / 968-0 - info@de.lq-group.com

6 Construction Destination

6.1 Pole diagram Target



6.2 Construction Destination

DESIGNATION	VALUE	UNIT
Size of construction	X-TEC 15	
locking type	Quick release fastener	
Type of plug-in contact (head 2)	free plug-in socket	
Number of poles	6	
arrangement of the cable lead-in (head 2)	straight	
Material Seals	NBR	
production type	overmoulded	
Housing material	Technomelt	
Material Insulating body	PA 6.6	
Design of the electrical connection (head 2)	Crimp connection	
Material Contacts	Copper alloy, hard silver plated	
contact resistance	<3	mOhm
Mechanical life Contacts	500	mating cycles
degree of protection	IP66/67	

27.10.2023-RSP	Adaptation Eclass	12.0		UL- Identification	Order no.	
17.04.2019-CP	Creation	11		W-TEC 15K-GCS-GCS-61414-XX-PX	1138014-xxxx	
12.11.2018-JH	Creation	10		Designation	Datasheet	
03.08.2023-RSP	New: IEC 61076-2-116	6.0		W-TEC 15K STI/BU 6x2,5 DA0	Created	Page
Change No.	Description of changes	Index			27.10.2023-RSP	8

The information contained in this data sheet was compiled with the greatest possible care.
For correctness, completeness and topicality the liability is limited to gross negligence.
All rights reserved to DIN 34

LQ Mechatronik-Systeme GmbH
Carl-Benz-Str. 6 D-74354 Besigheim
Tel. +49 (0) 71 43 / 968-0 - info@de.lq-group.com

6.3 Space requirement target

DESIGNATION	VALUE	UNIT
(a1) max. plug diameter	22	mm
(b1) Plug length	78	mm
(x1) in mated condition	116,1	mm
(x2) additional distance to interfering contour plugged in	18	mm

6.4 Schematic diagram Target

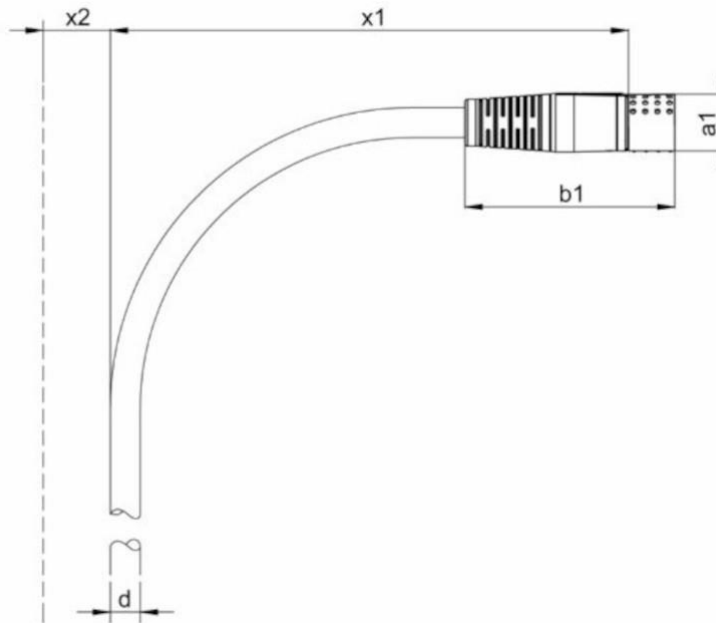



27.10.2023-RSP	Adaptation Eclass	12.0		UL- Identification	Order no.	
17.04.2019-CP	Creation	11		W-TEC 15K-GCS-GCS-61414-XX-PX	1138014-xxxxx	
12.11.2018-JH	Creation	10		Designation	Datasheet	
03.08.2023-RSP	New: IEC 61076-2-116	6.0		W-TEC 15K STI/BU 6x2,5 DA0	Created	Page
Change No.	Description of changes	Index			27.10.2023-RSP	9

The information contained in this data sheet was compiled with the greatest possible care.
 For correctness, completeness and topicality the liability is limited to gross negligence.
 All rights reserved to DIN 34

LQ Mechatronik-Systeme GmbH
 Carl-Benz-Str. 6 D-74354 Besigheim
 Tel. +49 (0) 71 43 / 968-0 - info@de.lq-group.com

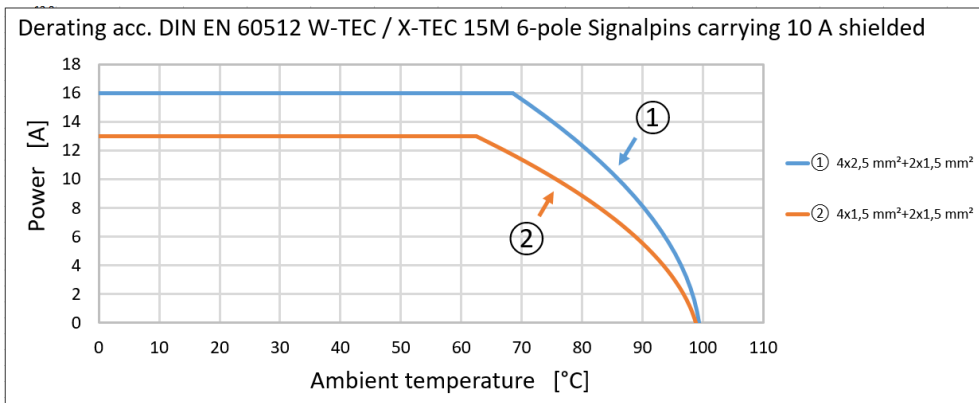
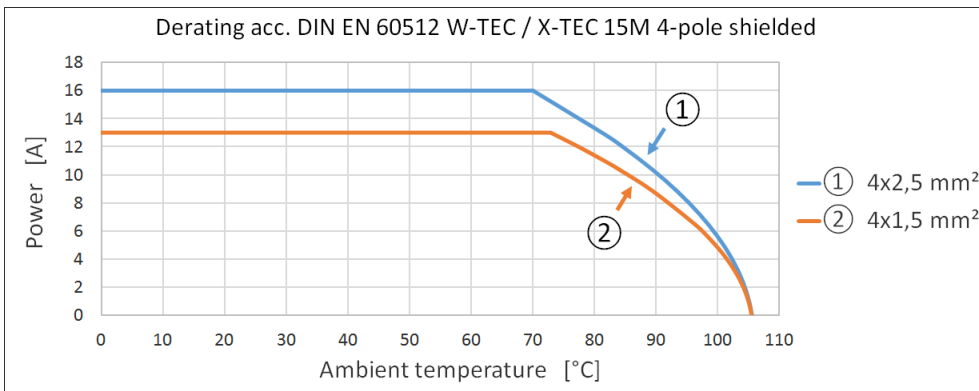
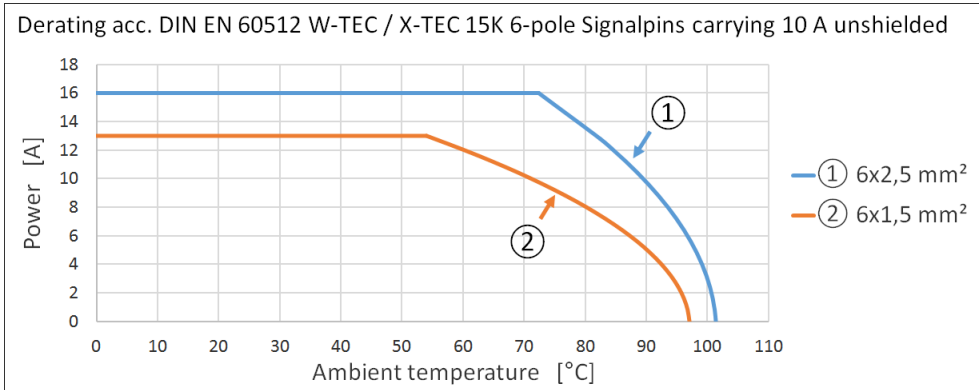
7 Derating



27.10.2023-RSP	Adaptation Eclass	12.0		UL- Identification	Order no.	
17.04.2019-CP	Creation	11		W-TEC 15K-GCS-GCS-61414-XX-PX	1138014-xxxxx	
12.11.2018-JH	Creation	10		Designation	Datasheet	
03.08.2023-RSP	New: IEC 61076-2-116	6.0		W-TEC 15K STI/BU 6x2,5 DA0	Created	Page
Change No.	Description of changes	Index			27.10.2023-RSP	10

The information contained in this data sheet was compiled with the greatest possible care. For correctness, completeness and topicality the liability is limited to gross negligence. All rights reserved to DIN 34

LQ Mechatronik-Systeme GmbH
 Carl-Benz-Str. 6 D-74354 Besigheim
 Tel. +49 (0) 71 43 / 968-0 - info@de.lq-group.com

8 Appendix Nomenclature

W - T E C 1 5 K - G C S - G C S - 6 1 4 1 4 - X X - T X -

Family designation

- W-TEC
 - Cable Assemblies
 - Cable Fittings

Connector Size

- 15
- 12

Connector type

- K – plastic connector
- M – metal connector

Male/Female contactor type

- G – straight
- F – angled left
- R – Angled right
- X – No male/female connector

Male/Female contact type

- C – crimp
- X – No male/female connector
- T – No Male/female connector, additional terminal/ferrule crimped to wire ends, resistance welded wire ends, single wire lengths may be varying (Female Panel mounted)

Male/Female contact plating

- S – Silver
- X – No male/female connector

Cable Screen

- S – shielded cable
- X – cable not shielded

Cable Type

- T – TPU
- P – PVC (applicable for cable not shielded variants only)

Cable gland size

- XX – no cable gland

Signal contact terminal cross-section

- 14 – AWG 14
- 16 – AWG 16
- XX – no signal contacts

Power contact terminal cross-section

- 14 – AWG 14
- 16 – AWG 16

Number of poles

- 4 – 4 poles
- 6 – 6 poles

1 1 1 9 8 8 7 - 0 0 1 0 0

internal description, where xxxxxx can be 7 digit alphanumeric

internal description, where xxxxxx can be 7 digit alphanumeric

- Ferrules with insulating collar
- Uninsulated ferrules
- Terminal Connectors,
- Uninsulated Terminal Connectors,
- dust caps

and additional features which may be

- welded/compacted stranded wire ends
- additional stripping of wire
- additional stripping of cord isolation
- length difference between power, ground and signal wires

five digit number describing cable length in cm

27.10.2023-RSP	Adaptation Eclass	12.0		UL- Identification	Order no.	
17.04.2019-CP	Creation	11		W-TEC 15K-GCS-GCS-61414-XX-PX	1138014-xxxx	
12.11.2018-JH	Creation	10		Designation	Datasheet	
03.08.2023-RSP	New: IEC 61076-2-116	6.0		W-TEC 15K STI/BU 6x2,5 DA0	Created	Page
Change No.	Description of changes	Index			27.10.2023-RSP	11

The information contained in this data sheet was compiled with the greatest possible care. For correctness, completeness and topicality the liability is limited to gross negligence. All rights reserved to DIN 34

LQ Mechatronik-Systeme GmbH
Carl-Benz-Str. 6 D-74354 Besigheim
Tel. +49 (0) 71 43 / 968-0 - info@de.lq-group.com